

① Fitted depending on features

Designation Connection Diagram GV640 / 440 ll. Gen	LCS EN	Document No. 5600 0001074481	Rev C	Sheet-No. 1 of 1
		Material No. 9000505353		

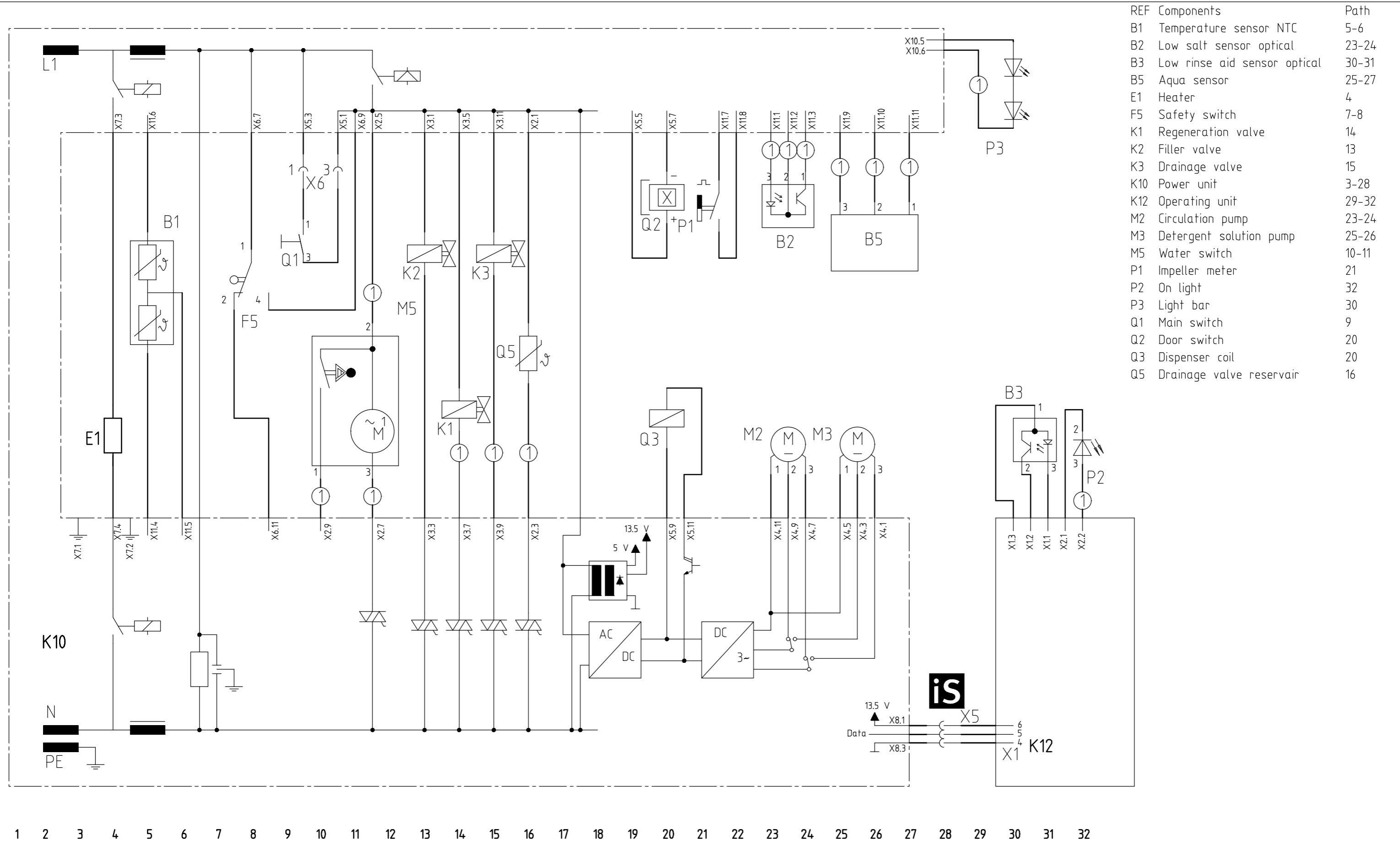

















REF	Components	Path
B1	Temperature sensor NTC	5-6
B2	Low salt sensor optical	23-24
B3	Low rinse aid sensor optical	30-31
B5	Aqua sensor	25-27
E1	Heater	4
F5	Safety switch	7-8
K1	Regeneration valve	14
K2	Filler valve	13
K3	Drainage valve	15
K10	Power unit	3-28
K12	Operating unit	29-32
M2	Circulation pump	23-24
M3	Detergent solution pump	25-26
M5	Water switch	10-11
P1	Impeller meter	21
P2	On light	32
P3	Light bar	30
Q1	Main switch	9
Q2	Door switch	20
Q3	Dispenser coil	20
Q5	Drainage valve reservoir	16

① Fitted depending on features







Designation Circuit Diagram GV 640 / 440 II Generation	LCS EN	Document No. 5600 0001073685	Rev C	Sheet-No. 1 of 1
		Material No. 9000505352		

Fault Codes and Service Programmes

Display CS Program		Display Customer		Description	Appliance behaviour	Results of internal check	Measures
Display	LED Act. Clean Sani mm End 	Display	LED End 	 LED off  LED on  flashes slow  flashes quick			
E:00	  			No error	---		---
h:00 – h:24				No error	Appliance does not start	Delay timer is activated!	No appliance fault!
All LED's are on				Interface error	Appliance without function	Appliance must be disconnected from the power supply after flash process (main switch on/off is not adequate!)	
  LED's flashing					Stops in current position, Appliance without function	Communication error between the electronics	<ul style="list-style-type: none"> - Check D-bus plug-and-socket connections (3-pole wire) for electrical connection faults - Disconnect appliance from the power supply (unplug and plug in again) - Run Flash process again - Replace module
E:01	 	E:01		Internal fault power module	→ End of programme	Pump control or pump switchover defective	Replace the power module
E:02		E:02			Operates without heater	Working relay for heater defective	
E:03		E:03			Operates without auxiliary drying system	Working relay for auxiliary heater defective	
E:04		E:04			Operates without heater	- Ground fault at zeolite heater - Safety relay heater defective	- Replace zeolite heater - Replace the power module
					Due to manufacture, new appliances until FD9108 may have stored error code E:04 once during the first 8 wash cycles.		No appliance fault!
E:05		E:05			Water switch is running continuously → programme termination with draining	Triac for water switch motor defective	Replace the power module
E:06		E:06		Door Hall sensor fault	Stops in current position, appliance without function	Wire to the Hall sensor interrupted or power module defective	Check wire / plugs Measure supply voltage on the Hall sensor
					Hall sensor defective		→ If voltage on the Hall sensor is o.k., replace Hall sensor







	Document-No.: 5600 0000171699 ASP EN	Revision F	Page No.
Fault Codes PM II	Material-No.: 9000.558.958		1 of 5

Fault Codes and Service Programmes

Display CS Program		Display Customer		Description	Appliance behaviour	Results of internal check	Measures	
Display	LED	Display	LED	 LED off  LED on  flashes slow  flashes quick				
	Act. Clean Sani mm End 		End 					
E:07				Heating fault	Operates without auxiliary drying system	Fan defective or blocked, module on the fan defective	Check components and connection wires, measure winding. (Only on appliances with Zeolite drying system)	
E:08					Operates without heater	Heat pump detects too low water level in pump sump.	Heat exchanger valve leaky	
E:09		E:09				Low voltage	Bowls / pans overturned in the appliance? no appliance fault!	
E:10						Heating circuit interrupted (resistance, supply wires, contacts of the safety relay on power module)	Measure heater resistance Check wires	
E:10						Operates without Zeolite - drying system (Applies only to appliances with Zeolite drying system)	Zeolite heater heating circuit interrupted (resistance / supply wires)	Measure heater resistance Check wires
							Fan module defective	Check component
							Wires interrupted	Check wires
E:11			E:11			Operates without heater	NTC resistance values outside permitted range	Measure NTCs
E:12				Wire or plug interrupted	Check wires / plugs			
E:12				Operates without auxiliary drying system	NTC resistance values outside permitted range	Measure NTCs		
E:13				Operates without heater	Water temperature too high (>75 °C)	Protective measure – no appliance fault! Check temperature of water supply		









	Document-No.: 5600 0000171699 ASP EN	Revision F	Page No.
Fault Codes PM II	Material-No.: 9000.558.958		2 of 5

Fault Codes and Service Programmes

Display CS Program		Display Customer		Description	Appliance behaviour	Results of internal check	Measures
Display	LED Act. Clean Sani mm End	Display	LED End	 LED off  LED on  flashes slow  flashes quick			
E:14		E:14	● ●	Filling fault	Programme stops with draining	No impulses from flow sensor, although water is detected by heat pump	Check wires, test flow sensor (reed switch)
E:15		E:15	● 		Programme stops with intermittent pumping	Base carrier safety switch active. Appliance cannot be switched off	Search for cause of water in the base carrier
E:16		E:16	●		Programme stops with draining	Water supply (impulses from flow sensor) without activation of the filling valve	Check filling valve Check actuation of filling valve
E:17		E:17	●		Wait for supply; programme stops with draining	Water supply rate too high according to flow sensor	Check flow controller in the filling valve
E:18			●			Water supply rate too low according to flow sensor or no water supply	Check water supply
E:19				Circulation pump fault		Reserved	---
E:20		E:20	●		→ End of programme	Resistance values of heat pump wrong	Check wires / plugs Measure resistance values of windings
E:21		E:21	●		→ End of programme	Heat pump blocked	Check heat pump for foreign objects, if required replace



	Document-No.: 5600 0000171699 ASP EN	Revision F	Page No.
Fault Codes PM II	Material-No.: 9000.558.958		3 of 5

Fault Codes and Service Programmes

Display CS Program		Display Customer		Description	Appliance behaviour	Results of internal check	Measures
Display	LED	Display	LED	 LED off  LED on  flashes slow  flashes quick			
	Act. Clean Sani mm End 		End 				
E:22		E:22	● ●	Drain pump fault	→ End of programme	Residual water in the pump sump, as filters dirty	Clean filters
E:23		E:23	●		→ End of programme	Resistance values of drain pump wrong	Check wires / plugs Measure resistance values of windings
E:24		E:24	● ●		→ End of programme	Non-return valve leaky	Check non-return valve for leaks
						Draining not possible. Drain pump cover missing from pump sump	Check water drainage (hose kinked, blocked, delivery height, pump cover) → Attach drain pump cover
E:25		E:25	● ●		→ End of programme	Drain pump blocked (from FD 9101 till FD 9108)	Check drain pump for foreign objects
	Drain pump blocked			Check drain pump for foreign objects			
E:26				Water switch fault	Permanet activation of water switch	No impulses from water switch despite actuation	Check wires Measure mains voltage on the motor Test switch at water switch
					Undervoltage fault	→ End of programme	Continuous undervoltage (<170 V)
E:27		E:27	●				
E:28				AquaSensor fault	Operates without AquaSensor	Appliance without AquaSensor	Appliance equipped with AquaSensor?
						Calibration of AquaSensor not successful	Check wires AquaSensor dirty?

Fault Codes PM II	Document-No.: 5600 0000171699 ASP EN	Revision F	Page No.
	Material-No.: 9000.558.958		4 of 5

Fault Codes and Service Programmes

Display CS Program		Display Customer		Description	Appliance behaviour	Results of internal check	Measures	
Display	LED	Display	LED	 LED off  LED on flashes slow flashes quick				
	Act. Clean Sani mm End		End					
E:29					Internal error codes	Stops in current position, appliance without function, Malfunctions, unsatisfactory rinsing / drying result	Undervoltage (<170 V / 190 V)	No appliance fault!
E:30			Appliance switches off			Overvoltage (>290 V)	No appliance fault!	
E:31						Reserved	Not relevant to customer service	
E:32				Reserved		Not relevant to customer service		

	Document-No.: 5600 0000171699 ASP EN	Revision F	Page No.
Fault Codes PM II	Material-No.: 9000.558.958		5 of 5

Customer Service Program

Function	Display	Remark				
	Display	Can be skipped	Time (s)	Value	Check / Measure	Remark

1.1 Customer Service Program

Preparation					Remove approx. 0.5 l water from salt dispenser.	Regeneration valve must be checked for leaks at appropriate customer specifications (see also steps with display S:04 + S:17)
CoilCheck	S:00	No	approx 20			Check the drain pump. Activate the drain pump and place the water switch in the top basket position.
Check flow sensor and flow controller	S:01	No	approx . 10-100			Add 50 ml (filling valve, drainage pump and circulation pump are activated in succession).
Pause	S:02	No	10			
Fill + pump	S:03	No	approx 100			Heat exchanger is overfilled, residual quantity in the pump sump is pumped off ==> heat exchanger full (contains 3.1 l water).
Pause	S:04	No	10		Visual inspection: water level in salt dispenser.	No change to water level ==> Regeneration valve leakproof.
Fill	S:05	No	approx 40	1,5 l	Check waterinlet amount	Within of 40s should the filling amount achieved. The heat exchanger will be overfilled.
Pause	S:06	No	10		Visual inspection: water level in appliance.	Water level on upper edge of fine mesh filter (= 1.5 l in pump sump).
Fill	S:07	No	approx 60	2,5 l		Total: 4 l in appliance
Circulate	S:08	No	15			Circulation pump must not "snorkel".
Dispense (detergent)	S:09	No	10			

	Document-No.: 56000000171137 ASP EN	Revision A	Seite-Nr.
Function Test Program	Material-No.: 9000.541.213		1 of 3

Customer Service Program

Function	Display	Remark				
	Display	Can be skipped	Time (s)	Value	Check / Measure	Remark
Circulate + heat + calibrate AquaSensor	S:10	Nein	110			
Circulate + heat	S:11	Yes		40 °C		Increase of temperature during heating +2.5 °C/min
Pause	S:12	No	5			
Circulate + dispense (rinse aid)	S:13	No	60			Number of impulses = set value of dispensed rinse aid
Circulate + heat + change position of water switch	S:14	Yes	approx 480	65 °C		Increase of temperature during heating +2.5 °C/min. Change every 30 s roof shower head, top basket, bottom basket.
Pump off	S:15	No	45			Tightness test of outlet valve Water-level at heat exchanger is not supposed to falling off
Drain heat exchanger	S:16	No	60			Check outlet valve
Pause	S:17	No	10		Visual inspection: water level in appliance.	Water level must be over handle of coarse filter
Pump off + drain heat exchanger + fill + regenerate	S:18	No	approx 20			Drain the complete appliance
Pause	S:19	No	10		Visual inspection: water level in salt dispenser.	Water level in salt dispenser must be increased by several cm.
Pump off + drain heat exchanger + fill	S:20	No	approx 100	4 l		Rinse the brine solution out of the heat exchanger and pump sump.

	Document-No.: 56000000171137 ASP EN	Revision A	Seite-Nr.
Function Test Program	Material-No.: 9000.541.213		2 of 3

Customer Service Program

Function	Display	Remark				
	Display	Can be skipped	Time (s)	Value	Check / Measure	Remark
Pump off + drain (heat exchanger)	S:21	No	30			Drain the complete appliance
Check whether appliance was drained (activates circulation pump and drain pump)	S:22	No	approx 10-120			Self-check whether appliance was drained.
End of test programme	„0“ on display or „End LED“ is lit				Switch off main switch	Test has ended. When the appliance is next switched on, the normal rinse programme is displayed

1.2 Reset program

Reset					Perform reset	Is possible at any time by pressing the button "Start" for longer than 3 seconds

	Document-No.: 56000000171137 ASP EN	Revision A	Seite-Nr.
Function Test Program	Material-No.: 9000.541.213		3 of 3

Service-Programme

Function	Actuation	Display	Remark
----------	-----------	---------	--------

1.1 Operating diagram

			<p>Button name</p> <p>Panels are by way of example, different designs are possible</p>
--	--	--	--

1.2 Special programmes

<p>Precondition</p>			<p>Switch on the appliance:</p> <ul style="list-style-type: none"> - Appliance is in rinsing program -> in this case carry out "Reset", switch off the appliance and switch it on again. - Appliance is in program selection -> in this case see next step (selection)
<p>Selection</p>			<p>Switch off the appliance</p>
			<p>Press and hold down buttons "B" + "C"</p>
			<p>Press the main switch</p>

	<p>Document-No.: 5600 0000156877 ASP EN</p>	<p>Revision G</p>	<p>Seite-Nr.</p>
<p>Request Service-Programme</p>	<p>Material-No.: 9000.361.481</p>		<p>1 of 3</p>

Service-Programme

Function	Actuation	Display	Remark
		Start ○ P0	Release buttons when P0 is displayed
Select		Start ○ P0 ... P7	Press button "B" until required programme is selected
		P0 P1 P2 P3 P4 P5 P6 P7	Error memory Customer service test programme Not relevant to customer service Not relevant to customer service Not relevant to customer service Not relevant to customer service Not relevant to customer service Demonstration programme

1.3 Read out error memory

		Start ○ P0	Activate: Press button "C"
		Start ○ C:00...C:07 E:00...E:32	Storage space number: Hold down button "C" Storage space contents (fault code): Release button "C"

1.4 Customer service test programme

		Start ○ P1	Press button "B" until P1 is displayed
		Start ○ S:00...S:xy	Activate: Press button "C"
Skip test step		Start ○ S:00...S:xy	Press button "B" Not all test steps can be skipped (see customer service test programme)

	Document-No.: 5600 0000156877 ASP EN	Revision G	Seite-Nr.
Request Service-Programme	Material-No.: 9000.361.481		2 of 3
The reproduction, transmission or use of this document or its contents is not permitted without express written authority. Offenders will be liable for damages. All rights including rights created by patent grant or registration of a utility model or design are reserved. Copyright reserved.			

Service-Programme

Function	Actuation	Display	Remark
----------	-----------	---------	--------

1.5 Special programme stopped

In error memory (P0)	① ↑ (A) (B) (C)	Start ○	Switch off main switch
In customer service test programme (P1)	① (A) (B) (C)	Start ↑ ○	0:01 Press "Start" button for 3 seconds (Reset)
	① ↑ (A) (B) (C)	Start ○	Switch off main switch

1.6 Demonstration programme

Select	① (A) (B) (C) ↑	Start ○	P7 Press button "B" until P7 is displayed
	① (A) (B) (C) ↑	Start ○	1:23 Activate: Press button "C"
	Door		If operation from front: Open and close door again If operation from above: Close and open door and close again
End	Door		Only if operation from above: When programme is running, open door
	① (A) (B) (C)	Start ↑ ○	0:01 Press "Start" button for 3 seconds (Reset)
	① (A) (B) (C) ↑ ↑	Start ○	Hold down buttons "B" + "C"
	① ↑ (A) (B) (C)	Start ○	Switch off main switch

	Document-No.: 5600 0000156877 ASP EN	Revision G	Seite-Nr.
Request Service-Programme	Material-No.: 9000.361.481		3 of 3
The reproduction, transmission or use of this document or its contents is not permitted without express written authority. Offenders will be liable for damages. All rights including rights created by patent grant or registration of a utility model or design are reserved. Copyright reserved.			